

Data Sheet



Article number: 432000640

Description: Rota-fix shaft-hub connection A 640x750
Steel

Note: Not self centering. Medium-high torques.

Measures

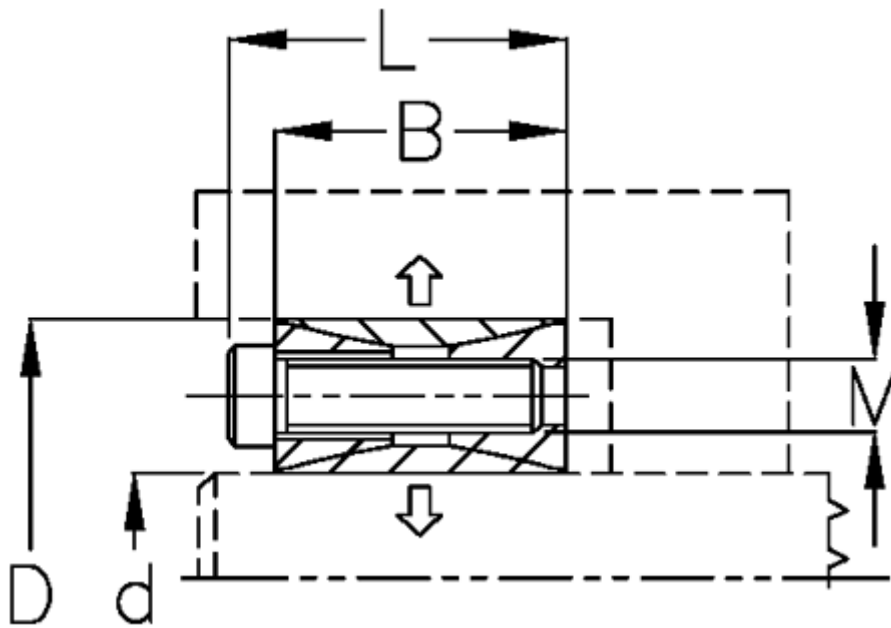

B mm	= 102
d H8 mm	= 640750
D mm	= 750
Fit tolerance	= Aksel k11-h11, Nav N11-H11
F kN torque	= 3019.0
L mm	= 130
M mm	= M24
P N/mm ² surface pressure on shaft/hub	= 111

Surface roughness	=
T N m torque	=
Ts N m bolt tightening torque	=